

## Turn, Tail and Stop Lights

Universal light features backup window and license illuminator. 1/4" diameter threaded studs are set in a 2" triangular pattern. Lead wires included.

Part No.	Qty/Pkg	Lens Color
MZ-445-S	pkg/1 (Display)	Red/White
MZ-445-X	pkg/10 (Bulk)	Red/White
MZ-445-MC	case/50	Red/White



**Part No. MZ-445**  
Turn, Tail, Stop and Backup Bolt-on

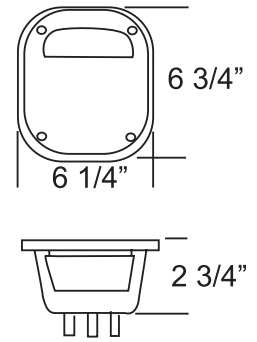

Universal light has 2 1/4" threaded studs set on 2" centers. Lead wires included.

Part No.	Qty/Pkg	Lens Color
MZ-440-S	pkg/1 (Display)	Red
MZ-440-X	pkg/10 (Bulk)	Red
MZ-440-MC	case/50	Red



**Part No. MZ-440**  
Turn, Tail and Stop Bolt-on

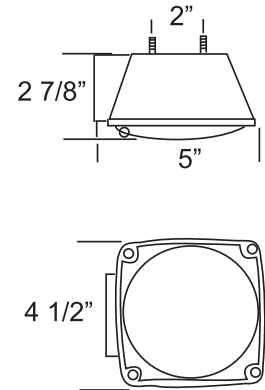

Universal light has 2 1/4" threaded studs set on 2" centers. Includes license illuminator. Lead wires included.

Part No.	Qty/Pkg	Lens Color
MZ-440L-S	pkg/1 (Display)	Red
MZ-440L-X	pkg/10 (Bulk)	Red
MZ-440L-MC	case/50	Red



**Part No. MZ-440L**  
Turn, Tail, Stop, License Illuminator Bolt-on

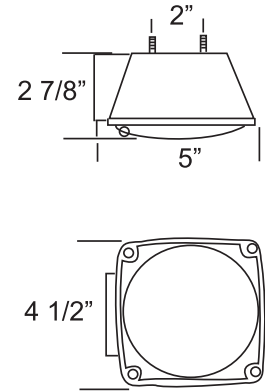

Universal light has 2 1/4" threaded studs set on 2" centers. Features license illuminator. Lead wires included.

Part No.	Qty/Pkg	Lens Color
MZ-428-S	pkg/1 (Display)	Red
MZ-428-X	pkg/10 (Bulk)	Red
MZ-428-MC	case/100	Red

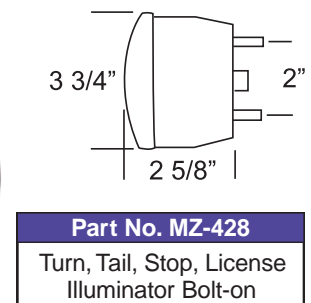

**Part No. MZ-428**  
Turn, Tail, Stop, License Illuminator Bolt-on

## LED Stop, Turn and Tail Light

2" x 6" oval, 6-diode LED stop, turn and tail light.

Part No.	Qty / Pkg	Lens Color
MZ-420R-3-S	pkg/1	Red
MZ-420R-3-X	pkg/10	Red



## Turn and Tail Lights / Miscellaneous Lights

Part No.	Qty/Pkg	Lens Color
MZ-146R-S	pkg/1 (Display)	Red
MZ-146R-X	pkg/10 (Bulk)	Red
MZ-146R-MC	case/200	Red
MZ-146A-S	pkg/1 (Display)	Amber
MZ-146A-X	pkg/10 (Bulk)	Amber
MZ-146A-MC	case/200	Amber



2" sealed light.  
Installation requires  
a MZ-142-49 pigtail  
and a MZ-146-18  
grommet.

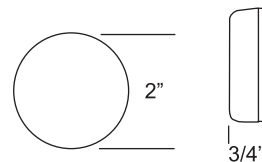

**Part No. MZ-146**  
Marker and Clearance  
Grommet Mount

Part No.	Qty/Pkg	Lens Color
MZ-143R-S	pkg/1 (Display)	Red
MZ-143R-X	pkg/10 (Bulk)	Red
MZ-143R-MC	case/200	Red
MZ-143A-S	pkg/1 (Display)	Amber
MZ-143A-X	pkg/10 (Bulk)	Amber
MZ-143A-MC	case/200	Amber

2 1/2" sealed light. Installation  
requires #MZ-142-49 pigtail  
and either #MZ-143-18 or  
a MZ-142-18 grommet.

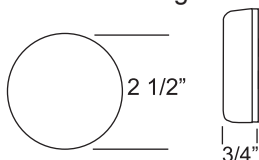

**Part No. MZ-143**  
Marker and Clearance  
Grommet Mount



4" x 2" oblong light.  
Has snap-on lens, with  
2 replaceable bulbs.

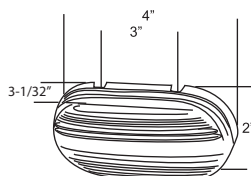

**Part No. MZ-135**  
Marker and Clearance  
Grommet Mount

Part No.	Qty/Pkg	Lens Color
MZ-135R-S	pkg/1 (Display)	Red
MZ-135R-X	pkg/10 (Bulk)	Red
MZ-135R-MC	case/200	Red
MZ-135A-S	pkg/1 (Display)	Amber
MZ-135A-X	pkg/10 (Bulk)	Amber
MZ-135A-MC	case/200	Amber

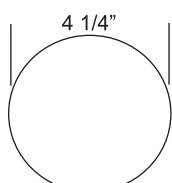

**Part No. MZ-415**  
Back Up  
Grommet Mount

Sealed white (backup) light. Install using grommet  
#MZ-426-18 and pigtail #MZ-431-49.

Part No.	Qty/Pkg	Lens Color
MZ-415-S	pkg/1 (Display)	White
MZ-415-X	pkg/10 (Bulk)	White
MZ-415-MC	case/100	White

Snap-in license light. Fits into 1 1/4" diameter hole. Chromed, white half lens.

Part No.	Qty/Pkg	Lens Color
MZ-438-S	pkg/1 (Display)	White
MZ-438-X	pkg/10 (Bulk)	White
MZ-438-MC	case/200	White

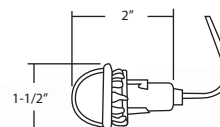

**Part No. MZ-438**  
Bumper Tag Light

## Miscellaneous Lights

Part No.	Qty/Pkg	Lens Color
MZ-063-S	pkg/1 (Display)	Amber
MZ-063-X	pkg/10 (Bulk)	Amber
MZ-063-MC	case/100	Amber

15" x 1.5" Amber, 3 Light Bar



**Part No. MZ-063**  
3 Light Bar

6" sealed, oval back-up light. Requires Grommet #MZ-421-18 and Pigtail #MZ-421-49.

Part No.	Qty/Pkg	Lens Color
MZ-416-S	pkg/1 (Display)	Clear
MZ-416-X	pkg/10 (Bulk)	Clear
MZ-416-MC	case/100	Clear



**Part No. MZ-416**  
Oval Back Up Light  
Clear

6" Sealed, oval turn signal light. Requires Grommet #MZ-421-18 and Pigtail #MZ-421-49.



**Part No. MZ-421**  
Oval Turn Signal Light  
Red

Part No.	Qty/Pkg	Lens Color
MZ-421R-S	pkg/1 (Display)	Red
MZ-421R-X	pkg/10 (Bulk)	Red
MZ-421R-MC	case/100	Red

3 13/16" amber front clearance light and a red rear clearance light. Requires mounting bracket #MZ-154-11.

Part No.	Qty/Pkg	Lens Color
MZ-154A-R-S	pkg/1 (Display)	Amber/Red
MZ-154A-R-X	pkg/10 (Bulk)	Amber/Red
MZ-154A-R-MC	case/100	Amber/Red

**Part No. MZ-154A-R**  
Fender Mount  
Clearance Light  
Half Amber / Half Red

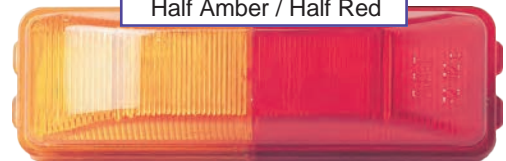

Part No.	Qty/Pkg	Lens Color
MZ-154-11K-S	pkg/1 (Display)	Black
MZ-154-11K-X	pkg/10 (Bulk)	Black
MZ-154-11K-MC	case/100	Black

**Part No. MZ-154-11-K**  
Mounting Bracket

Mounting bracket for  
light #MZ-154A-R

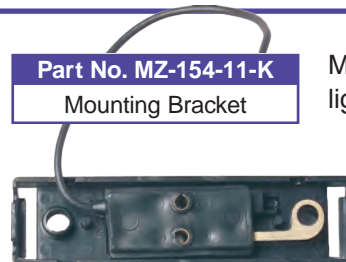

Chrome License Light

**Part No. MZ-435N**  
Chrome License Light



Part No.	Qty/Pkg	Lens Color
MZ-435N-S	pkg/1 (Display)	Clear
MZ-435N-X	pkg/10 (Bulk)	Clear
MZ-435N-MC	case/200	Clear



## Light Grommets

Black oblong PVC Grommet will mount 2" x 6" tail lights. **Application:** use with light #MZ-416 and #MZ-421



Part No.	Qty/Pkg
MZ-421-18-S	pkg/1 (Display)
MZ-421-18-X	pkg/10 (Bulk)
MZ-421-18-MC	case/100

Black PVC Grommet mounts 4" round tail lights. **Application:** use with light #MZ-415

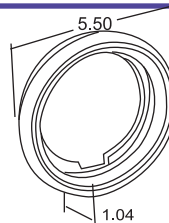

Part No.	Qty/Pkg
MZ-426-18-S	pkg/1 (Display)
MZ-426-18-X	pkg/10 (Bulk)
MZ-426-18-MC	case/100

Round black PVC grommet provides a flush mount for 2" marker lights. **Application:** use with light #MZ-146

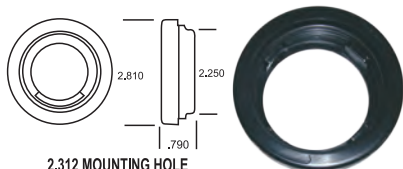

Part No.	Qty/Pkg
MZ-146-18-S	pkg/1 (Display)
MZ-146-18-X	pkg/10 (Bulk)
MZ-146-18-MC	case/200

Black PVC round grommet provides a recessed mount for 2 1/2" marker lights. **Application:** use with light #MZ-143

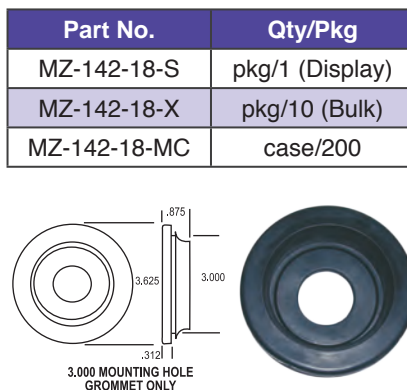

Part No.	Qty/Pkg
MZ-142-18-S	pkg/1 (Display)
MZ-142-18-X	pkg/10 (Bulk)
MZ-142-18-MC	case/200

Black PVC round grommet provides a flush mount for 2 1/2" marker lights. **Application:** use with light #MZ-143



Part No.	Qty/Pkg
MZ-143-18-S	pkg/1 (Display)
MZ-143-18-X	pkg/10 (Bulk)
MZ-143-18-MC	case/200

## Light Pigtails

Pigtail has 3 wires, 1 black, 1 red and 1 white with attached ring terminal.



Part No.	Qty/Pkg
MZ-431-491-S	pkg/1 (Display)
MZ-431-491-X	pkg/10 (Bulk)
MZ-431-491-MC	case/500

Pigtail has 2 wires, 1 black, 1 red and 1 white with attached ring terminal. **Application:** use with light #MZ-143 and #MZ-146



Part No.	Qty/Pkg
MZ-142-49-S	pkg/1 (Display)
MZ-142-49-X	pkg/10 (Bulk)
MZ-142-49-MC	case/500

Pigtail has 2 wires, 1 black and 1 white with attached ring terminal. **Application:** use with light #MZ-416

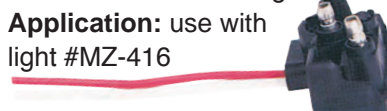

Part No.	Qty/Pkg
MZ-421-49-S	pkg/1 (Display)
MZ-421-49-X	pkg/10 (Bulk)
MZ-421-49-MC	case/500

Pigtail has 3 wires, 1 black, 1 red and 1 white with attached ring terminal. **Application:** use with most turn, tail and stop lights



Part No.	Qty/Pkg
MZ-421-491-S	pkg/1 (Display)
MZ-421-491-X	pkg/10 (Bulk)
MZ-421-491-MC	case/500

Pigtail has 2 wires, 1 black and 1 white with attached ring terminal. **Application:** use with light #MZ-415



Part No.	Qty/Pkg
MZ-431-49-S	pkg/1 (Display)
MZ-431-49-X	pkg/10 (Bulk)
MZ-431-49-MC	case/500